

Data Sheet

Peltier – Surface Cooler GR-208-C



S-0000593-001-a

Technical data:

Power supply	24 V - DC
Rated input	200 W
max. input current	15 A
Weight	ca. 6 kg
Protection Classification	IP67
Operational temperature range	-40 °C to 70 °C
Storage temperature range	-40 °C to 70 °C
Alarm transductor	make-contact, max. 30 V-DC, 5 A
Switch point fault message	+80°C (+/- 5°C) heat sink temperature
Switch point safety shutdown	+90°C (+/- 5°C) heat sink temperature

Performance range:

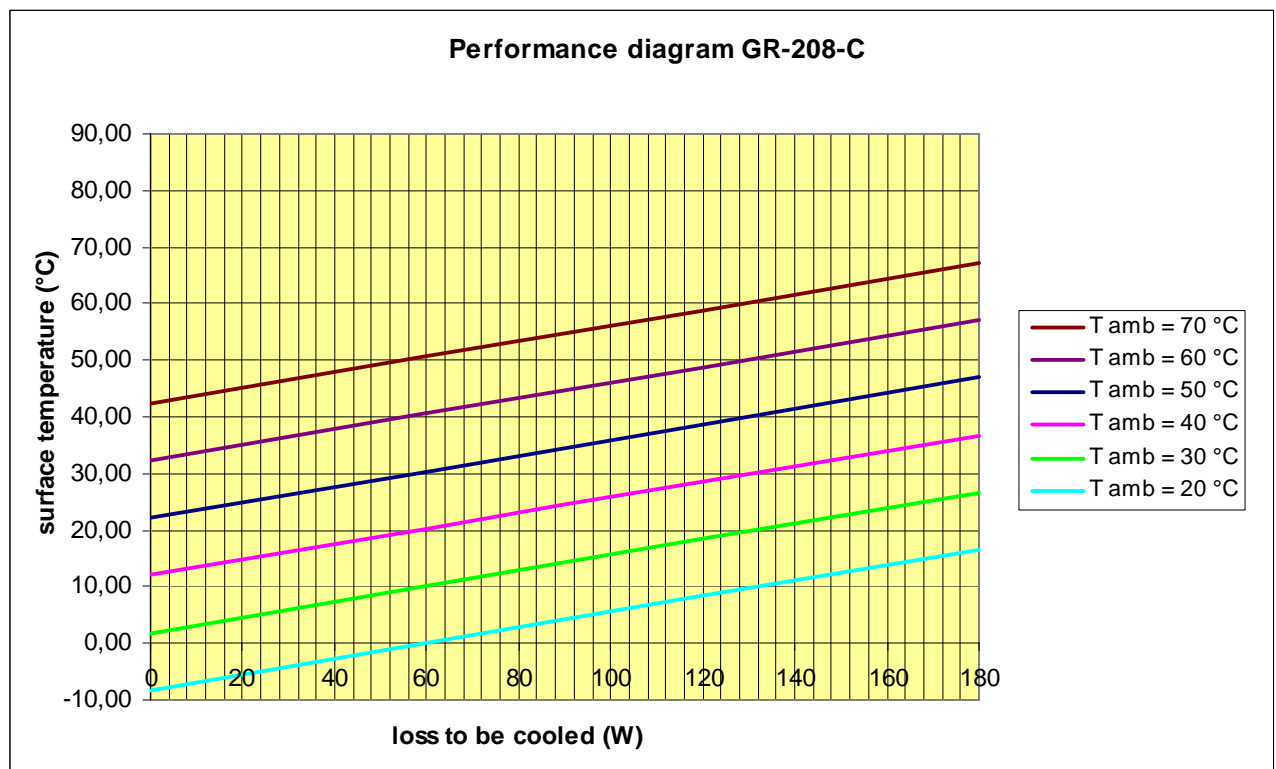

Terminal assignment:

Cable Color	Sleeve Color	Connection
Red	Yellow	+24 V - Peltier-Elements
Black	Yellow	0 V - Peltier-Elements
Blue	White	Alarm transductor (NO contact)
Blue	White	Alarm transductor (NO contact)
Red	Red	+24 V - Fan
Black	Red	0 V - Fan

Main dimensions:

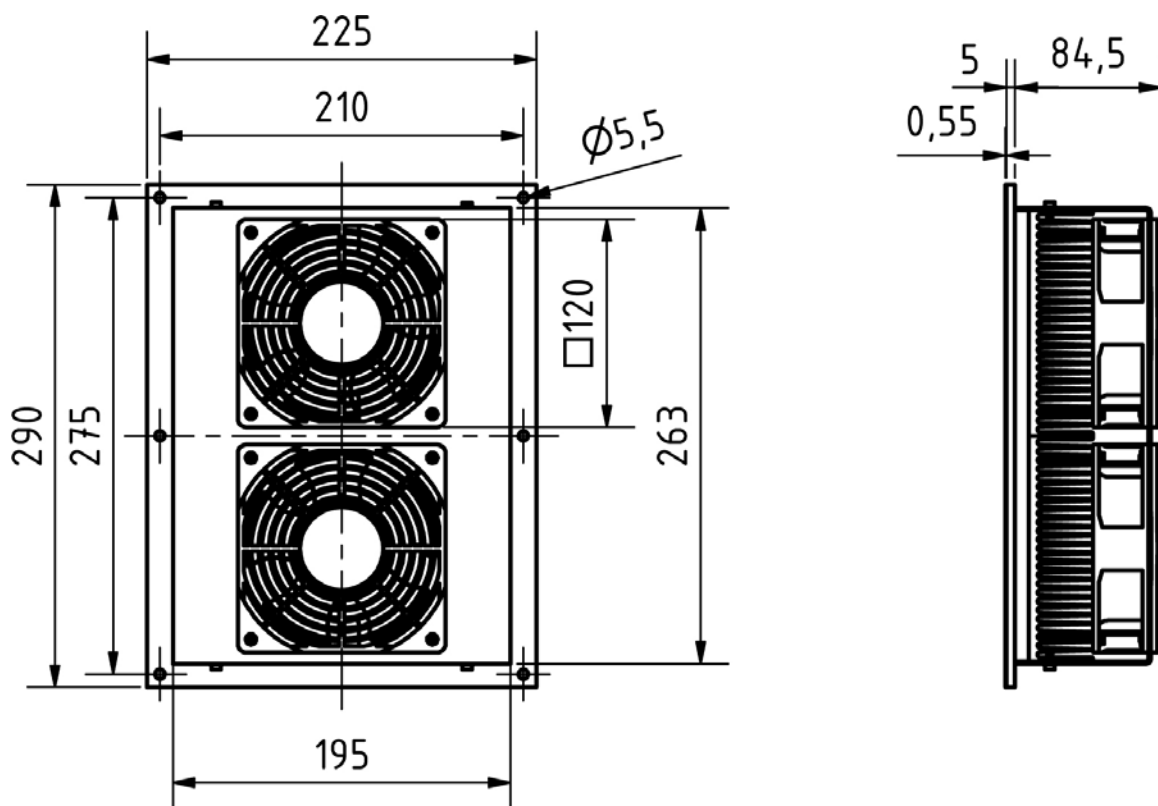



The product „DR. NEUMANN Surface Cooler – GR-208-C“ has been given the CE mark on the basis of the Directive 89/336/EEC of the Council of the European Community of 29 April 1991 for harmonization of legislation of member-states on communication systems including mutual recognition of their conformity.

This product has been designed for use with power packs bearing the CE mark.

The product „DR. NEUMANN Surface Cooler – GR-208-C“ meets the requirements for a CE mark:

Interference immunity to EN 50082-2

Electromagnetic compatibility; basic standard on interference immunity

Radio interference suppression to EN 55022 Class A

Electromagnetic compatibility of equipment for information processing and telecommunication

Electric safety to EN 60950

Safety of equipment of information engineering including electric office machines.

This product has been designed for use in industrial applications. Interference immunity and the rate of emitted interference are in conformity with the directives on industrial equipment. When the product is used in residential homes and business offices interference with other equipment items (e.g. radio receivers) might occur. The user shall ensure itself that no third party will be exposed to any interference.

This declaration is delivered in the responsibility of the manufacturer

DR. NEUMANN
Peltier-Technik GmbH
Gautinger Str. 45
D-82061 Neuried
Germany