





# Data Sheet

## Peltier Control-Cabinet-Cooler FL-316-C



S-0000197-004-a

### Technical Data:

Supply voltage	24 V - DC
Rated input	200 W
Cooling power (L35 / L35)	229 W
Max. input current	14 A
Rated current	8,3 A
Weight	app. 10 kg
Protection classification outer side (warm)	IP67
Protection classification internal side (cold)	IP20
Operational temperature range	-40 °C to 70 °C
Storage temperature range	-40 °C to 70 °C
Alarm transductor	NO-contact, max. 30 V-DC, 5 A
Switch point fault message	+80°C (+/- 5°C) heat sink temperature
Switch point safety shutdown	+90°C (+/- 5°C) heat sink temperature
Certificates / Approvals	    NEMA 1,12,4X File E468447

### Performance range:

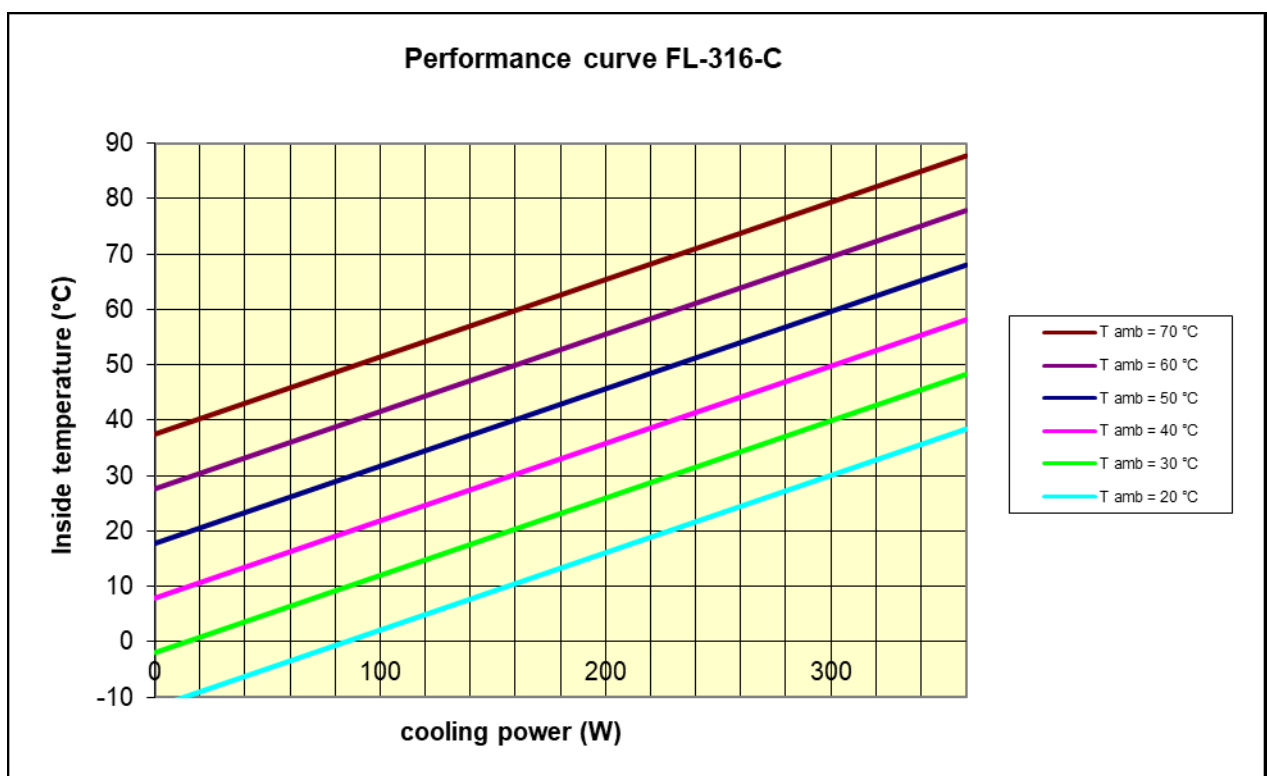

### Terminal assignment:

Terminal	Connection
1	+24 V-DC (Peltier +)
2	0 V-DC (Peltier -)
3	+24 V-DC (Peltier +)
4	0 V-DC (Peltier -)
5	Not in use
6	Not in use
7	+24 V-DC (External fans +)
8	0 V-DC (External fans -)
9	+24 V-DC (Internal fan +)
10	0 V-DC (Internal fan -)
11	+24 V-DC (Peltier +)
12	0 V-DC (Peltier -)
13	+24 V-DC (Peltier +)
14	0 V-DC (Peltier -)
15	Alarm transductor
16	Alarm transductor
17	+24 V-DC (External fans +)
18	0 V-DC (External fans -)
19	+24 V-DC (Internal fan +)
20	0 V-DC (Internal fan -)

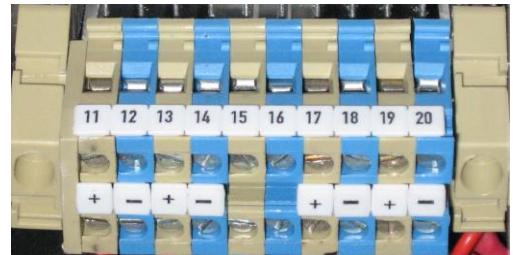
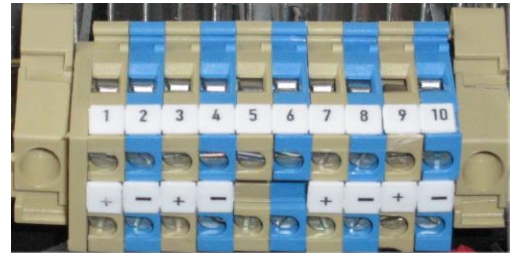

**Main dimensions:**

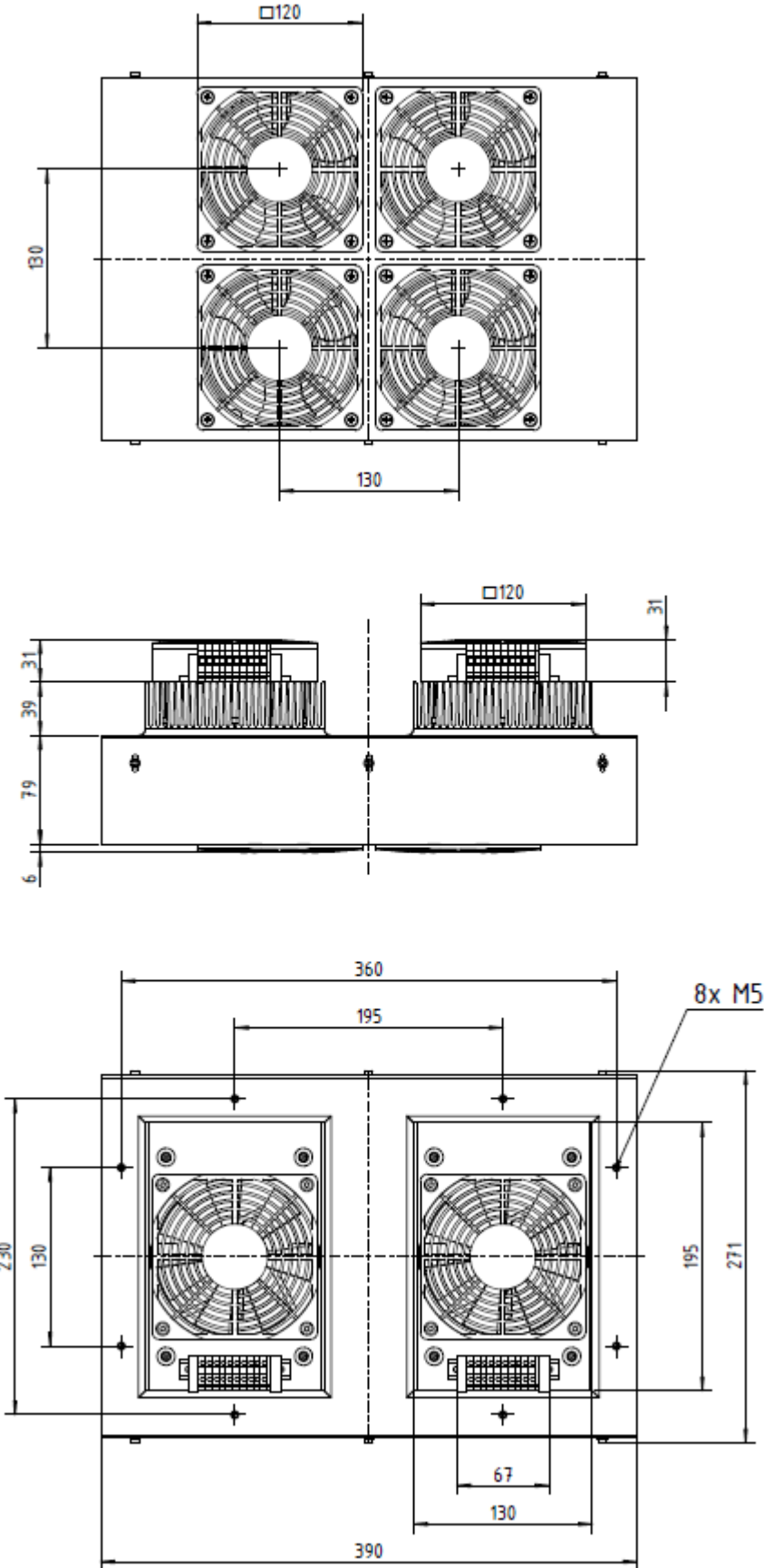

**Opening:**

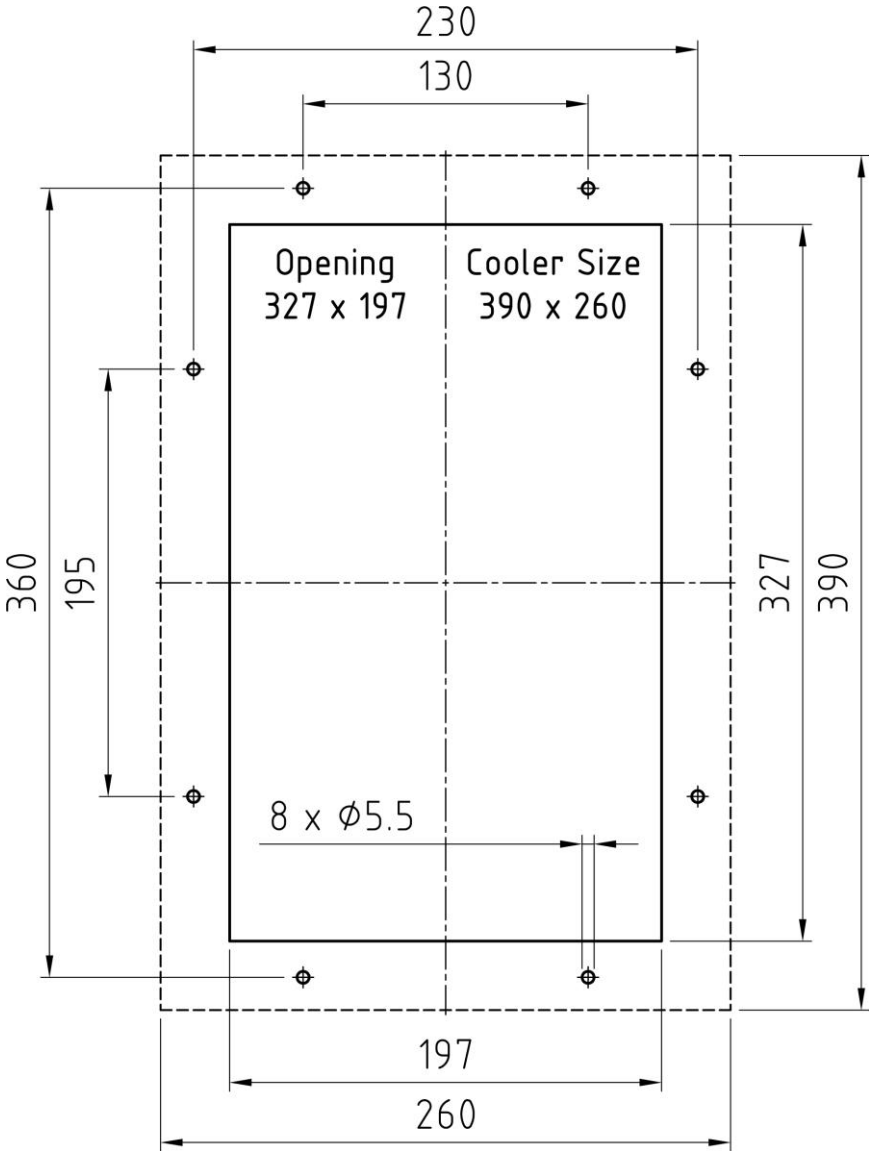

**Note on installation:**

The mounting position of the device is freely selectable. However, when installing into a side wall, rear wall or into the cabinet door, it is recommended that the device be aligned in such a way that the connection terminals are at the top.

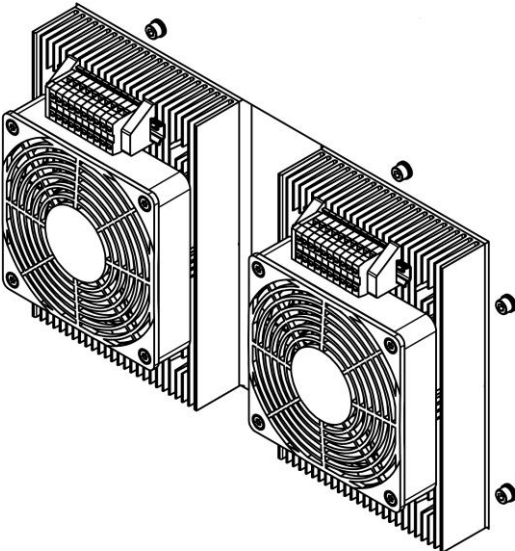



The product „DR. NEUMANN Peltier-Switch-Cabinet-Cooler FL-316-C“ has been given the CE mark on the basis of the Directive 3014/30/EU of the Council of the European Community of 26 February 2014 for harmonization of legislation of member-states on communication systems including mutual recognition of their conformity.

This product has been designed for use with power packs bearing the CE mark.

The product „DR. NEUMANN Peltier-Switch-Cabinet-Cooler FL-316-C“ meets the requirements for a CE mark:

**Interference immunity to EN 61000-6-2/VDE 0839 Part 6-2**

Electromagnetic compatibility; basic standard on interference immunity

**Radio interference suppression to EN 55022 Class A**

Electromagnetic compatibility of equipment for information processing and telecommunication

**Electric safety to EN 60950**

Safety of equipment of information engineering including electric office machines.

This product has been designed for use in industrial applications. Interference immunity and the rate of emitted interference are in conformity with the directives on industrial equipment. When the product is used in residential homes and business offices interference with other equipment items (e.g. radio receivers) might occur. The user shall ensure itself that no third party will be exposed to any interference.

This declaration is delivered in the responsibility of the manufacturer

DR. NEUMANN  
Peltier-Technik GmbH  
Gautinger Str. 45  
D-82061 Neuried  
Germany